

microSDカード
TLC:64-512GB
aTLC:16-128GB

(ET1289+SanDisk Bics4 3D-TLC)

データシート

REVISION HISTORY

Revision	Description	Date
V1.0	New release	February 2022

1. Product Introduction

1.1. Overview

The Industrial microSD Card is designed for demanding industrial applications.

The Industrial microSD Card is compatible with SD 3.0 and provides excellent performance.

The built-in auto ECC function can detect and correct errors during data transfer.

Moreover, the Industrial microSD Card supports Ultra High Speed (UHS) interface transfer mode, provides high write/read data transfer rate, high random IOPS, sudden Power-Fails protection, adaptive static wear-leveling, read/program disturb management, etc.

It was designed to meet the high quality, high reliability, high performance, and versatile environmental requirements.

1.2. Product Features

- Interface: 8 pins microSD standard interface
- Compliant SD Card Specification Ver. 3.0 / 4.1 / 5.1 / 6.1
- Density support:
 - TLC:64GB~512GB
 - aTLC (Advanced TLC, single bit per cell TLC): 16GB~128GB
- Bus Speed Mode:
 - DS-Default Speed mode: 3.3V signaling, frequency up to 25MHz, up to 12.5MB/sec
 - HS-High Speed mode: 3.3V signaling, frequency up to 50MHz, up to 25MB/sec
 - SDR12: 1.8V signaling, frequency up to 25MHz, up to 12.5MB/sec
 - SDR25: 1.8V signaling, frequency up to 50MHz, up to 25MB/sec
 - SDR50: 1.8V signaling, frequency up to 100MHz, up to 50MB/sec
 - SDR104: 1.8V signaling, frequency up to 208MHz, up to 104MB/sec
 - DDR50: 1.8V signaling, frequency up to 50MHz, sampled on both clock edges, up to 50MB/s
- Operating at -25°C to 85°C
- Flash: 3D-TLC NAND Flash (SanDisk Bics4)
- Controller: ET1289
- Program/Erase Cycle:
 - TLC: 3,000 Cycles
 - aTLC: 30,000 Cycles
- Built-in ECC corrects up to 120bits/1 KB
- Read disturbance management (Auto-Refresh)
- Adaptive wear leveling
- Management of sudden power-fails
- SMART Function support
- aTLC (Advanced TLC, single bit per cell TLC) support, enhance the performance and product endurance

1.3. TBW (Tera Bytes Written)

Capacity	16GB	32GB	64GB	128GB	256GB	512GB
TLC	—	—	TBD	TBD	TBD	TBD
aTLC	366.6TB	735.1TB	1469.9TB	2932.8TB	—	—

*The endurance of disk could be varying based on user behavior, NAND endurance cycles, and write amplification factor. It is not guaranteed by flash vendor.

*Client workload by JESD-219A

2. microSD Card Interface Description

2.1 microSD Pin Assignment

Table 1: SD Bus Mode Pin Definition

Pin #	Name	Type	SD Description
1	DAT2	I/O	Data Line [Bit2]
2	CD/DAT3	I/O	Card Detect / Data Line [Bit3]
3	CMD	PP	Command / Response
4	VDD	S	Supply Voltage
5	CLK	I	Clock
6	VSS	S	Supply Voltage Ground
7	DAT0	I/O	Data Line [Bit 0]
8	DAT1	I/O	Data Line [Bit 1]

Notes:

- 1) S: power supply; I: input; O: output using push-pull drivers; PP: I/O using push-pull drivers.
- 2) The extended DAT Lines (DAT1-DAT3) are input on power up. They start to operate as DAT lines after SET_BUS_WIDTH command. The Host shall keep its own DAT1-DAT3 lines in input mode, as well, while they are not used. It is defined so, in order to keep compatibility to Multi-media Cards.
- 3) After power up this line (Pin2) is input with 50Kohm pull-up (can be used for card detection or SPI mode selection). The pull-up should be disconnected by user, during regular data transfer, with SET_CLR_CARD_DETECT (ACMD42) command.

Table 2: SPI Bus Mode Pin Definition

Pin #	Name	Type	SD Description
1	RSV		Reserved
2	CS	I	Chip Select (neg true)
3	DI	I	Data In
4	VDD	S	Supply Voltage
5	SCLK	I	Clock
6	VSS	S	Supply Voltage Ground
7	DO	O	Data Out
8	RSV		Reserved

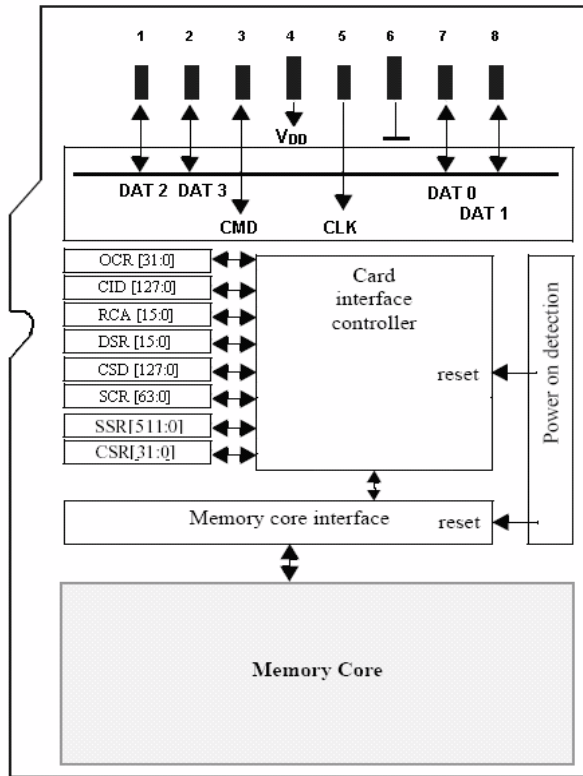

Figure 1: Functional Diagram

3. Specifications

3.1. Performance

Max. Data Transfer Rate

- Read: 90MB/s; Write: 70MB/s

3.2. NAND Flash Memory

Industrial microSD Card uses Triple Level Cell (TLC) NAND Flash memory, which is non- volatility, high reliability and highspeed memory storage.

3.3. Power Requirement

3.3.1. DC Input Voltage

- 2.7V to 3.6V

3.4. Temperature Range

- -25°C to +85°C

3.5. Humidity

Relative Humidity: 5-95%, non-condensing

3.6. Waterproof

Waterproof level: IEC 60529 IPX8.

Test Condition	Referred standard
Depth of water 1.5m for 30 mins.	IEC 60529 IPX8

3.7. ESD Ability

Test Condition	Referred standard
● Contact discharge: ± 2KV, ± 4KV	SD Spec. Appendix D.1
● Air discharge: ± 4KV, ± 8KV, ± 15KV	SD Spec. Appendix D.2

3.8. Dust proof

Dust proof level: IEC 60529 IP6X.

Test Condition	Referred standard
Depression of 2 KPa, Talcum powder 2kg/m ³ , 8 hrs.	IEC 60529 IP6X

4. Electrical Specifications

4.1 General DC Character

Table 3: General DC Character

Parameter	Symbol	Min	Max	Unit	Remark
Peak voltage on all lines	—	-0.3	3.6	V	
All input leakage current	—	-10	10	μA	
All output leakage current	—	-10	10	μA	
Supply voltage for low voltage range	V_{DDL}	—	—	V	
Supply voltage for high voltage range	V_{DDH}	2.7	3.6	V	
Supply voltage differential	—	-0.5	0.5	V	

4.2 Bus Signal Line Loading

Table 4: Bus Signal Line Loading

Parameter	Symbol	Min	Max	Unit	Remark
Pull up resistance for SD command line	R_{CMD}	4.7	100	$\text{K}\Omega$	
Pull up resistance for SD data line	R_{DAT}	10	100	$\text{K}\Omega$	
Total Bus capacitance for each signal line	C_L	—	30	pF	
Signal line inductance	—	—	16	pF	
Pull-up resistance inside card (pin 1)	R_{DAT3}	10	150	$\text{K}\Omega$	

4.3 Bus Signal Levels

As the bus can be supplied with a variable supply voltage, all signal levels are related to the supply voltage.

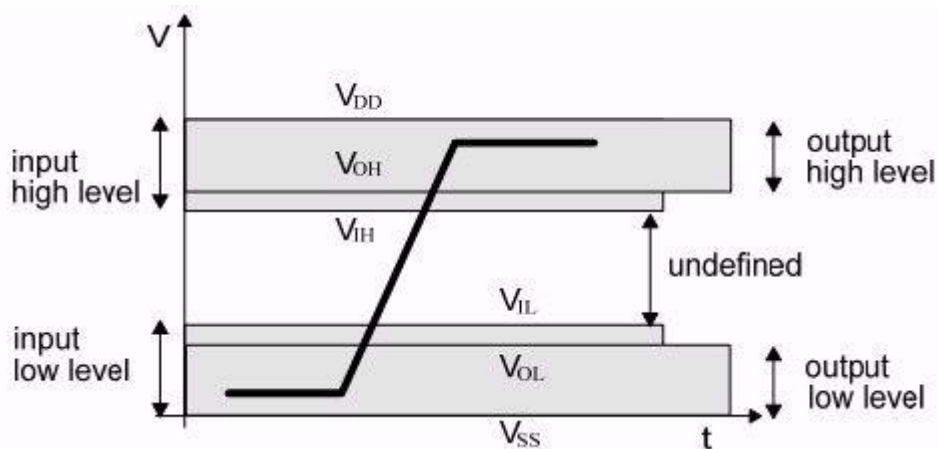

Figure 4: Bus Signal Levels

Table 5: Bus Signal Level

Parameter	Symbol	Min	Max	Unit	Remark
Output High Voltage	V_{OH}	2.4	—	V	$V_{DD} = 3.3V$
Output Low Voltage	V_{OL}	—	0.4	V	$V_{DD} = 3.3V$
Input High Voltage	V_{IH}	2.0	3.6	V	$V_{DD} = 3.3V$
Input Low Voltage	V_{IL}	-0.3	0.8	V	$V_{DD} = 3.3V$
Output High Voltage	V_{OH}	1.4	—	V	$V_{DD} = 1.8V$
Output Low Voltage	V_{OL}	—	0.45	V	$V_{DD} = 1.8V$
Input High Voltage	V_{IH}	1.26	2.1	V	$V_{DD} = 1.8V$
Input Low Voltage	V_{IL}	-0.3	0.58	V	$V_{DD} = 1.8V$

4.4 Bus Timing (Default Speed Mode)

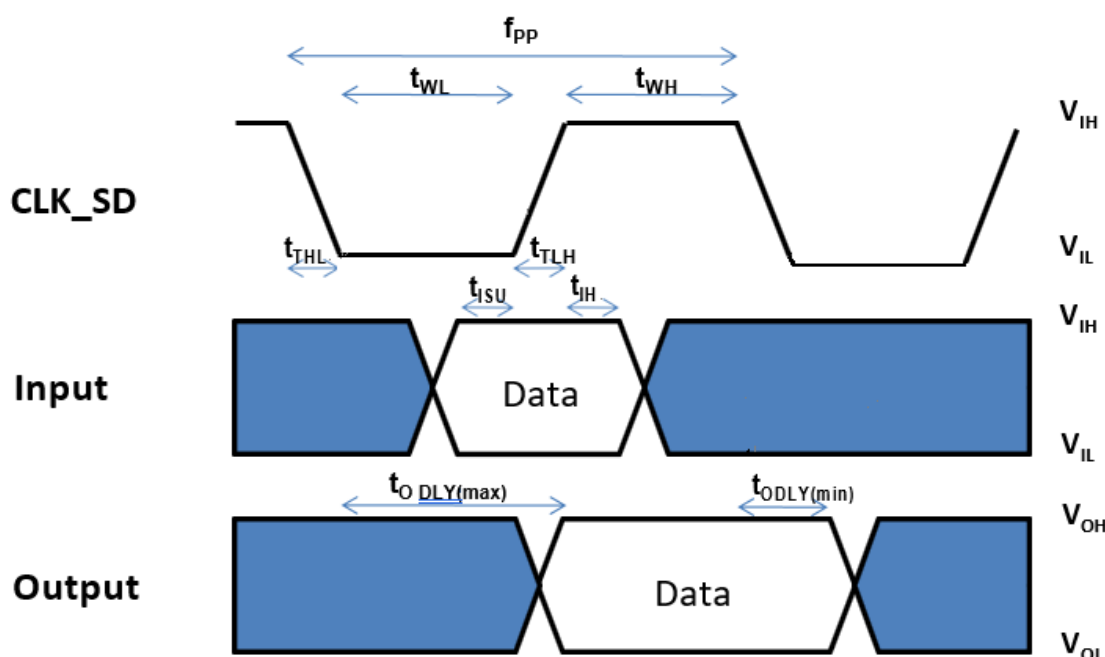

Figure 5: Timing diagram data input/output referenced to clock (Default Speed Mode)

Table 6: Bus Timing - Parameters Values (Default Speed)

Parameter	Symbol	Min.	Max.	Unit	Remark
Input CLK_SD					
Clock frequency data transfer mode	f_{pp}	—	25	MHz	$C_L \leq 10pF$ (1 card)
Clock frequency Identification mode	f_{OD}	—	400	KHz	$C_L \leq 10pF$ (1 card)
Clock low time / Clock high time	t_{WL}/t_{WH}	10	—	ns	$C_L \leq 10pF$ (1 card)
Clock rise time / Clock fall time	t_{TLH}/t_{THL}	—	10	ns	$C_L \leq 10pF$ (1 card)
Input CMD_SD/DATA_SD, referenced to CLK_SD					
Input set-up time	t_{ISU}	5	—	ns	$C_L \leq 10pF$ (1 card)
Input hold time	t_{IH}	5	—	ns	$C_L \leq 10pF$ (1 card)
Output CMD_SD/DATA_SD, referenced to CLK_SD					
Output Delay time during Data Transfer Mode	t_{ODLY}	—	14	ns	$C_L \leq 40pF$ (1 card)
Output Delay time during Identification Mode	t_{ODLY}	—	50	ns	$C_L \leq 40pF$ (1 card)

- (1) All timing values are measured relative to 50% of voltage level.
 (2) Rise and fall times are measured from 10% - 90% of voltage level.

4.5 Bus Timing (High-Speed Mode)

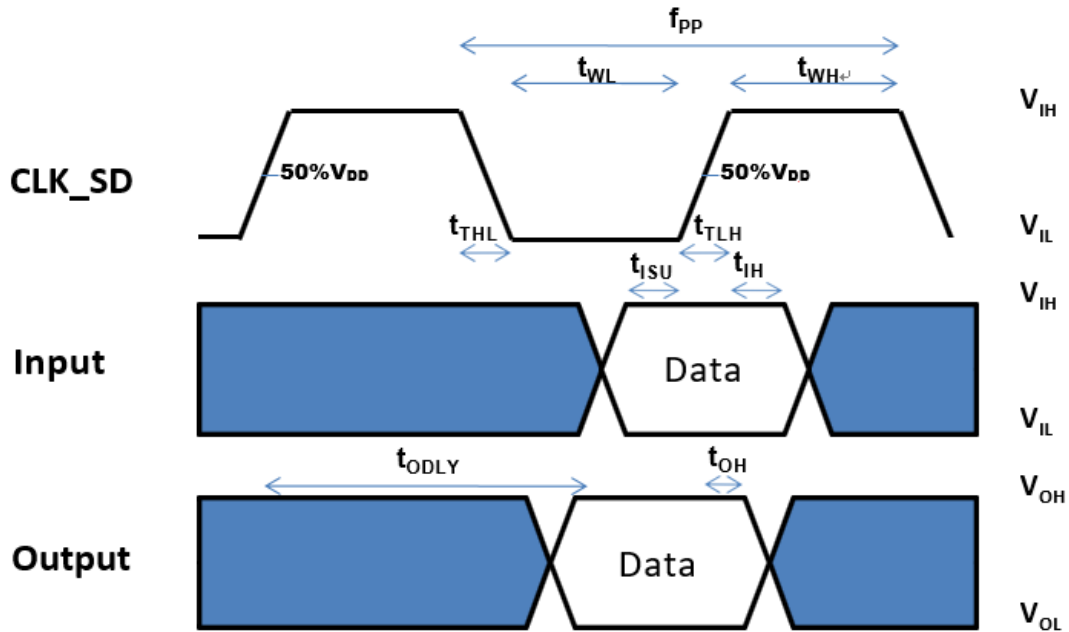

Figure 6: Timing diagram data input/output referenced to clock (High-Speed Mode)

Table 7: Bus Timing - Parameters Values (High-Speed)

Parameter	Symbol	Min.	Max.	Unit	Remark
Input CLK_SD					
Clock frequency data transfer mode	f_{pp}	0	50	MHz	$C_L \leq 10\text{pF}$ (1 card)
Clock low time / Clock high time	t_{WL}/t_{WH}	7	—	ns	$C_L \leq 10\text{pF}$ (1 card)
Clock rise time / Clock fall time	t_{TLH}/t_{THL}	—	3	ns	$C_L \leq 10\text{pF}$ (1 card)
Input CMD_SD/DATA_SD, referenced to CLK_SD					
Input set-up time	t_{ISU}	6	—	ns	$C_L \leq 25\text{pF}$ (1 card)
Input hold time	t_{IH}	2	—	ns	$C_L \leq 25\text{pF}$ (1 card)
Output CMD_SD/DATA_SD, referenced to CLK_SD					
Output Delay time during Data Transfer Mode	t_{ODLY}	—	14	ns	$C_L \leq 40\text{pF}$ (1 card)
Output hold time	t_{OH}	2.5	—	ns	$C_L \leq 15\text{pF}$ (1 card)
Total System capacitance for each line	C_L	—	40	pF	

- (1) All timing values are measured relative to 50% of voltage level.
- (2) Rise and fall times are measured from 10% - 90% of voltage level.

Table 8: Bus Timing - Parameters Values (SDR104/SDR50/SDR25/SDR12)

Parameter	Symbol	Min.	Max.	Unit	Remark
Input CLK_SD					
Clock frequency data transfer mode	f _{pp}	0	208	MHz	C _L = 10pF
Clock cycle time	t _{CLK}	4.8	—	ns	C _L = 10pF
Clock duty cycle		30	70	%	
Clock rise time / Clock fall time	t _{TLH} /t _{THL}	—	0.2*t _{CLK}	ns	C _L = 10pF
Input CMD_SD/DATA_SD, referenced to CLK_SD					
Input set-up time for SDR104	t _{ISU}	1.4	—	ns	C _L = 10pF
Input set-up time for SDR50	t _{ISU}	3	—	ns	C _L = 10pF
Input hold time	t _{IH}	0.8	—	ns	C _L = 5pF
Output CMD_SD/DATA_SD, referenced to CLK_SD					
Output Delay time for SDR50	t _{ODLY}	—	7.5	ns	C _L = 30pF, using driver Type B
Output Delay time for SDR25 and sdr12	t _{ODLY}	—	14	ns	C _L = 40pF, using driver Type B
Output hold time	t _{OH}	1.5	—	ns	C _L = 15pF
Total System capacitance for each line	C _L	—	40	pF	

4.6 Bus Timing (DDR Mode)

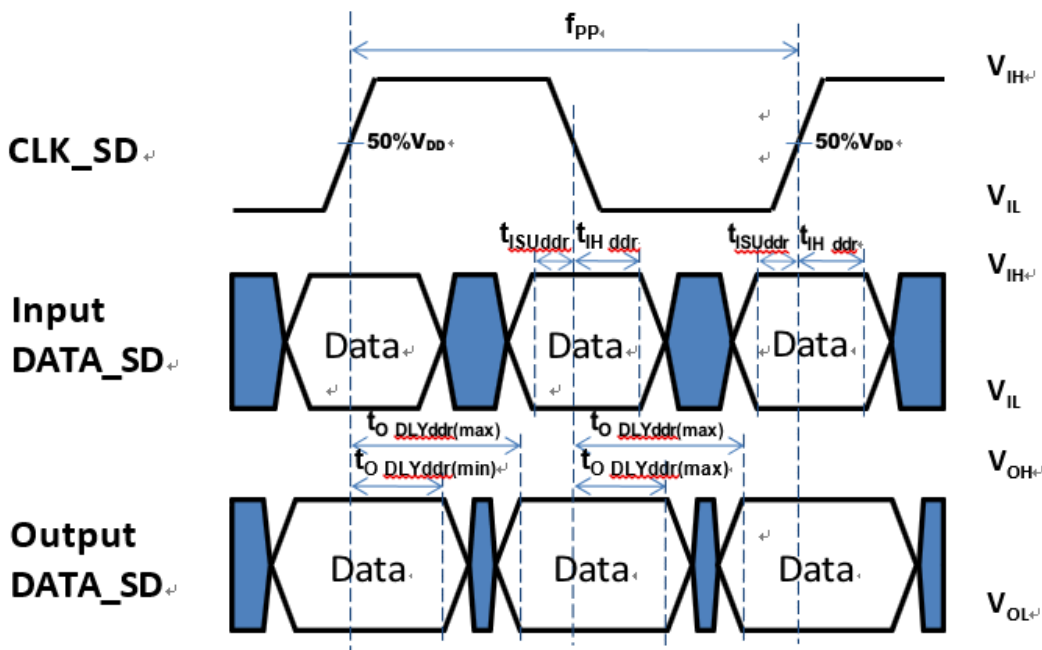

Figure 7: Timing diagram data input/output referenced to clock (DDR Mode)

Table 9 : Bus Timing - Parameters Values(DDR)

Parameter	Symbol	Min.	Max.	Unit	Remark
Input CLK_SD					
Clock duty cycle		45	55	%	
Input CMD_SD, referenced to CLK_SD					
Input set-up time	t _{ISU}	3	—	ns	C _L ≤ 10pF (1 card)
Input hold time	t _{IH}	0.8	—	ns	C _L ≤ 10pF (1 card)
Output CMD_SD, referenced to CLK_SD					
Output Delay time during data transfer mode	t _{ODLY}	—	13.7	ns	C _L ≤ 30pF (1 card)
Output hold time	t _{OH}	1.5	—	ns	C _L ≥ 15pF (1 card)
Input DATA_SD, referenced to CLK_SD					
Input set-up time	t _{ISUddr}	3	—	ns	C _L ≤ 10pF (1 card)
Input hold time	t _{IHddr}	0.8	—	ns	C _L ≤ 10pF (1 card)
Output DATA_SD, referenced to CLK_SD					
Output Delay time during data transfer mode	t _{ODLYddr}	—	7	ns	C _L ≤ 25pF (1 card)
Output hold time	t _{OHddr}	1.5	—	ns	C _L ≥ 15pF (1 card)

5. Mechanical Dimensions

The mechanical dimensions of industrial microSD card were basically followed the mechanical form factor definitions on microSD card specifications which constructed by SD card association.

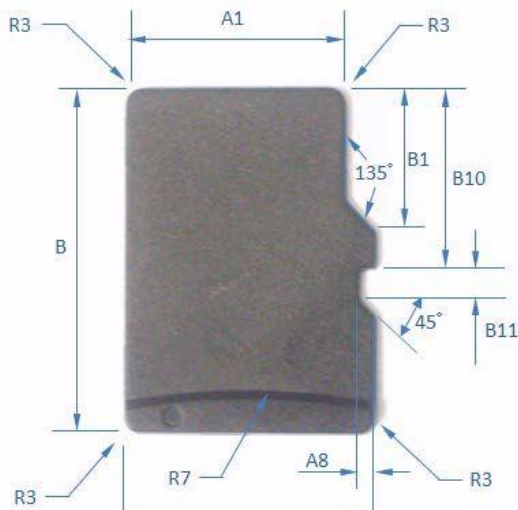

Figure 11: Top View

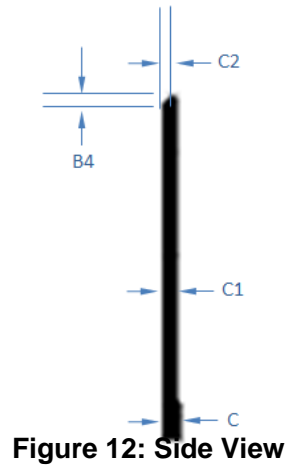

Figure 12: Side View

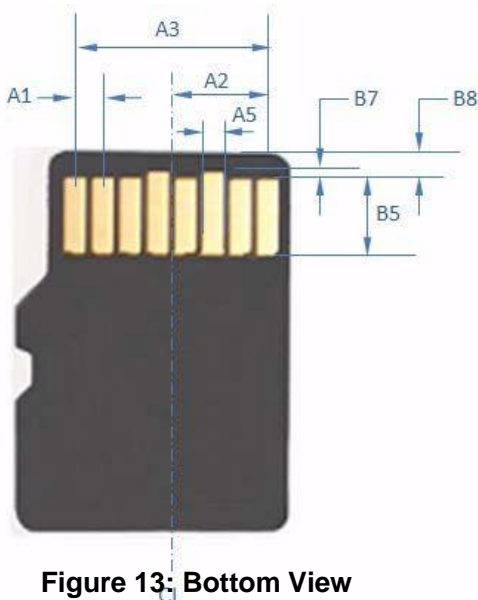

Figure 13: Bottom View

Criteria of microSD				Unit: mm
Dimensions	Min	TYP	Max	Note
A	10.90	11.00	11.10	
A1	9.60	9.70	9.80	
A2		3.85		BASIC
A3	7.60	7.70	7.80	
A4		1.10		BASIC
A5	0.75	0.80	0.85	
A8	0.60	0.70	0.80	
B	14.90	15.00	15.10	
B1	6.13	6.23	6.33	
B4	0.42	0.52	0.62	
B5	2.80	2.90	3.00	
B7	0.20	0.30	0.40	
B8	1.00	1.10	1.20	
B10	7.80	7.90	8.00	
B11	1.10	1.20	1.30	
R3	0.70	0.80	0.90	
R7	29.50	30.00	30.50	
C	0.90	1.00	1.10	
C1	0.60	0.70	0.80	
C2	0.20	0.30	0.40	

6. Ordering Information

Flash Type	Part Number	Capacity	Note
TLC	ADM1U1064G3DCEDES	64GB	TBD
	ADM1U1128G3DCEDES	128GB	TBD
	ADM1U1256G3DCEDES	256GB	TBD
	ADM1U1512G3DCEDES	512GB	TBD
aTLC	ADM1U1016GPDCEDES	16GB	
	ADM1U1032GPDCEDES	32GB	
	ADM1U1064GPDCEDES	64GB	
	ADM1U1128GPDCEDES	128GB	